

Suite 6631 R-SFLR - Right hand drain, 3 Skirts (Front, Left and Right)

Series : **Authentik Signature**

Nominal dimensions: **66" x 31" x 22" [167.6 cm x 78.7 cm x 55.9 cm]**

Seats : **1**

Product code: **SU6631R-SFLR**

Draft revision : **2023122210423**

Lumbar support : **yes**

Arm rests : **yes**

Low-profile available : **no**

Draft and specs

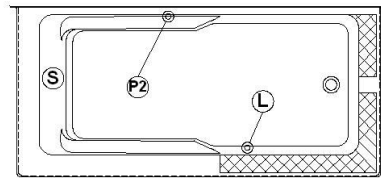
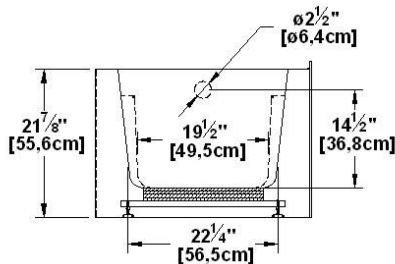
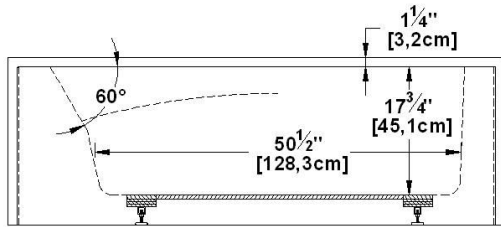
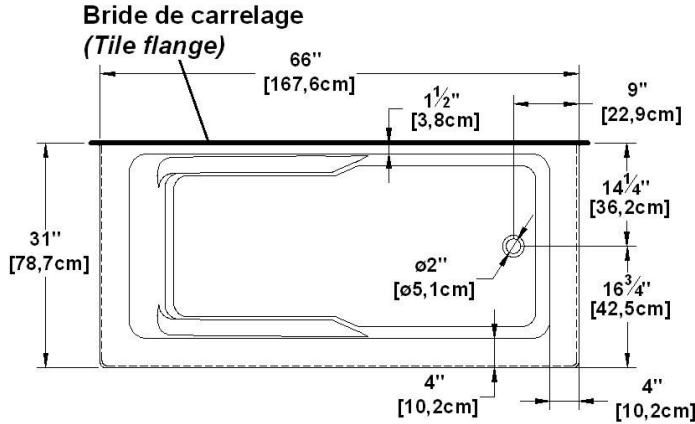

When ordered with a linear overflow (BDW), the installation panel option is mandatory.

Additional(s) note(s)





Integrated acrylic tile flanges.

Specifications
Capacity: 44 IMP Gal. / 57.3 US Gal. / 200 liters
AeroMassage™: 40 Easy Clean™ air jets
Super AeroMassage™: AeroMassage™ + 12 Easy Clean™ air jets
Comfort Air™: 40 Easy Clean™ air jets
Characteristics: 3 integrated skirts

Remarks
All measures have a precision of ± 1/4" (0,63cm)
If a measure is present on one side only, part is symmetrical
*internal dimensions taken at 4" (10cm) from bath bottom
*capacity is measured by filling the bath to 1-1/2" under the overflow

Available models
Soaker <input checked="" type="checkbox"/>
Comfort Air™ <input checked="" type="checkbox"/>
AeroMassage™ <input checked="" type="checkbox"/>
Super AeroMassage™ <input checked="" type="checkbox"/>

Available recommended options
Front skirt: Integrated
Recommended drain: WOCOSBS14 (chrome finish)
Tile flanges: Included on sides without skirt
Floating remote control: Available
Linear overflow: BDW114 (chrome finish)

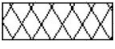
Legend	
 Blower	 Chromotherapy light
 Grab bar	 Keypad
 Recommended faucets drilling location*	Deck cut-out line - - - - -

*It is possible to install the faucets elsewhere on the product. The installer must verify that there are no piping or wires before drilling.

IMPORTANT NOTE: Specifications, dimensions and models are subject to change.

Visit our website <http://www.oceania-attitude.com> to access up-to-date dimensions and information. In all cases, information on the website is the most up-to-date.

Head office

591, avenue des Entreprises
Theftford Mines, Quebec
CANADA G6H 4B2

Contact numbers

Phone : 1-877-332-4224
Fax : 1-866-460-4334

Internet

Web : <http://www.oceania-attitude.com>
Email : info@bainsoceania.com