

**Urbania 6031 R-SFLR - Right hand drain, 3 Skirts (Front, Left and Right)**

Series : **Freestanding**

Nominal dimensions: **60" x 31" x 17.5" [152.4 cm x 78.7 cm x 44.5 cm]**

Seats : **1**

Product code: **UR6031R-SFLR**

Draft revision : **2024010912161**

Lumbar support : no

Arm rests : no

Low-profile available : no

**Draft and specs**

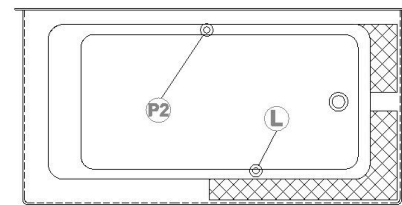
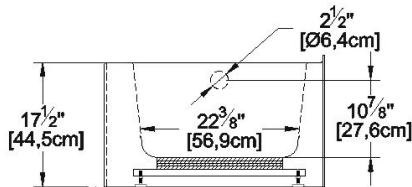
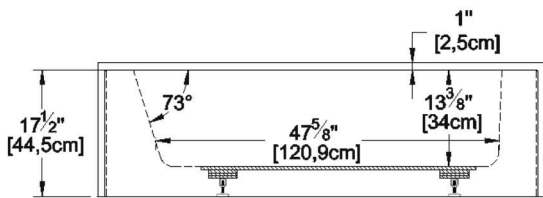
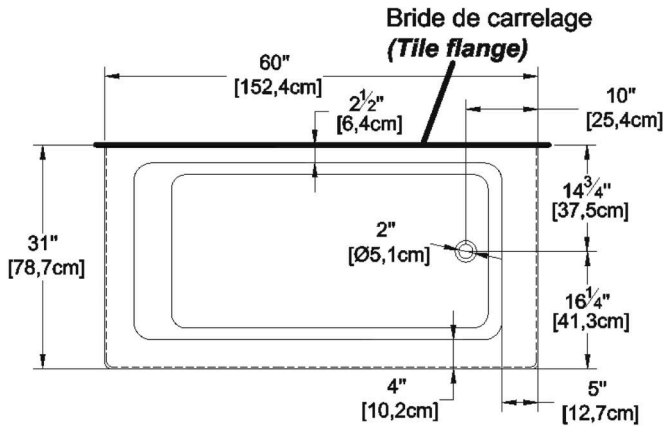





When ordered with a linear overflow (BDW), the installation panel option is mandatory.

Additional(s) note(s)

Integrated acrylic tile flanges.

**Legend**

-  Blower
-  Chromotherapy light
-  Grab bar
-  Keypad



Recommended faucets drilling location\*

Deck cut-out line - - - - -

\*It is possible to install the faucets elsewhere on the product. The installer must verify that there are no piping or wires before drilling.

**IMPORTANT NOTE:** Specifications, dimensions and models are subject to change.

Visit our website <http://www.oceania-attitude.com> to access up-to-date dimensions and information. In all cases, information on the website is the most up-to-date.

Head office

591, avenue des Entreprises  
Theftord Mines, Quebec  
CANADA G6H 4B2

Contact numbers

Phone : 1-877-332-4224  
Fax : 1-866-460-4334

Internet

Web : <http://www.oceania-attitude.com>  
Email : [info@bainsoceania.com](mailto:info@bainsoceania.com)